



**INSTITUTO DE CIENCIAS  
DE LA CONSTRUCCIÓN  
EDUARDO TORROJA**

C/ Serrano Galvache n. 4 28033 Madrid (Spain)  
Tel.: (34) 91 302 04 40  
[direccion.ietcc@csic.es](mailto:direccion.ietcc@csic.es) <https://dit.ietcc.csic.es>

**European Technical  
Assessment**

**ETA 15/0905  
of 01/08/2023**

English translation prepared by IETcc. Original version in Spanish language

**General Part**

**Technical Assessment Body issuing the ETA designated according to Art. 29 of Regulation (EU) 305/2011:**

Instituto de Ciencias de la Construcción Eduardo Torroja (IETcc)

**Trade name of the construction product:**

**AnchorMark AMDEX concrete screw**

**Product family to which the construction product belongs:**

Concrete screw of sizes, 6,8,10,12, and 14 for use in cracked and non-cracked concrete.

**Manufacturer:**

AnchorMark Pty Ltd  
Unit 1, 61 Waterview Close  
Dandenong VIC 3175  
Australia  
Website: [www.anchormark.com.au](http://www.anchormark.com.au)

**Manufacturing plants:**

AnchorMark Plant 1

**This European Technical Assessment contains:**

29 pages including 4 annexes which form an integral part of this assessment.

**This European Technical Assessment is issued in accordance with regulation (EU) No 305/2011, on the basis of:**

European Technical Assessment EAD 330232-01-0601 "Mechanical Fasteners for use in concrete", ed. December 2019

**This ETA replaces:**

ETA 15/0905 version 2 issued on 08/04/2022



*English translation prepared by IETcc*

This European Technical Assessment is issued by the Technical Assessment Body in its official language. Translations of this European Technical Assessment in other languages shall fully correspond to the original issued document and should be identified as such.

This European Technical Assessment may be withdrawn by the issuing Technical Assessment Body, in particular pursuant to information by the Commission according to article 25 (3) of Regulation (EU) No 305/2011.

Código seguro de Verificación : GEN-11d5-c140-0bf8-5e52-870e-46c4-4a6c-770c | Puede verificar la integridad de este documento en la siguiente dirección : <https://portafirmas.redsara.es/pf/valida>

---

CSV : GEN-11d5-c140-0bf8-5e52-870e-46c4-4a6c-770c

DIRECCIÓN DE VALIDACIÓN : <https://portafirmas.redsara.es/pf/valida>

FIRMANTE(1) : ANGEL CASTILLO TALAVERA | FECHA : 14/08/2023 15:34 | Sin acción específica



## SPECIFIC PART

### 1. Technical description of the product

The AnchorMark AMDEX concrete screw is a type of anchor made of carbon steel and stainless steel (bimetal). The anchor is made of carbon steel for sizes 6,8,10,12 and 14 and of stainless steel for sizes 6,8, and 10. Both of them are screwed into a predrilled cylindrical drill hole. The special thread of the anchor cuts an internal thread into the member while setting. The anchorage is characterised by mechanical interlock in the special thread.

The product and its installation description are shown in annexes A.

### 2. Specification of the intended use in accordance with the applicable European Assessment Document.

The performances given in section 3 are only valid if the anchor is used in compliance with the specifications and conditions given in annex B.

The verifications and assessment methods on which this European Technical Assessment is based lead to the assumption of a working life of the anchor of at least 50 years. The indications given on the working life cannot be interpreted as a guarantee given by the producer, but are to be regarded only as a means to choosing the right products in relation to the expected economically reasonable working life of the works.

### 3. Performance of the product and references to the methods used for its assessment

#### 3.1 Mechanical resistance and stability (BWR 1)

Essential characteristic	Performance
Static or quasi static actions	See annexes C1 to C7
Essential characteristic and displacements for seismic performance categories C1 and C2	See annexes C8 and C9

#### 3.2 Safety in case of fire (BWR 2)

Essential characteristic	Performance
Reaction to fire	Anchorage satisfy requirements for class A1
Resistance to fire	See annex D

### 4. Assessment and verification of constancy of performance (hereinafter AVCP) system applied, with reference to its legal base

The applicable European legal act for the system of Assessment and Verification of Constancy of Performances (see annex V of Regulation (EU) No 305/2011) is 96/582/EC.

The system to be applied is 1.



**5. Technical details necessary for the implementation of the AVCP system, as provided for in the applicable European Assessment Document.**

The technical details necessary for the implementation of the AVCP system are laid down in the quality plan deposited at Instituto de Ciencias de la Construcción Eduardo Torroja.



Instituto de Ciencias de la Construcción Eduardo Torroja  
CONSEJO SUPERIOR DE INVESTIGACIONES CIENTÍFICAS









C/ Serrano Galvache n.º 4. 28033 Madrid.  
Tel: (+34) 91 302 04 40  
<https://dit.ietcc.csic.es>

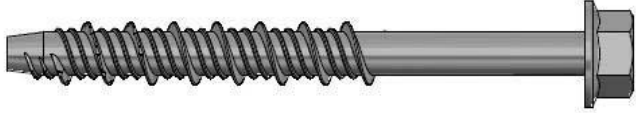















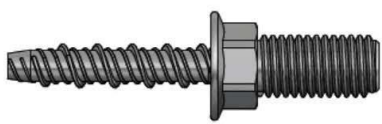

On behalf of the Instituto de Ciencias de la Construcción Eduardo Torroja  
Madrid, 01<sup>st</sup> of August 2023

Mr. Ángel Castillo Talavera  
Director IETcc - CSIC

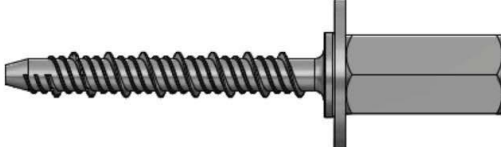

<b>Product and identification</b>	
	 AMDEX
	 AMRND
	 AMPAN
	 AMDAV
	 AMHEX
	 AMTEX
	 AMTRU
	 AMURI
AnchorMark AMDEX concrete screw	<b>Annex A1</b>
<b>Product description</b>	
Identification	



		AMDTH
		AMROD
		AMROF
		AMROH
		AMRHH
		AMROO
		AMRCC
		AMRHC
AnchorMark AMDEX concrete screw		<b>Annex A2</b>
<b>Product description</b>		
Identification		



English translation prepared by IETcc

	
AnchorMark AMDEX concrete screw	<b>Annex A3</b>
<b>Product description</b> Identification	

Código seguro de Verificación : GEN-11d5-c140-0bf8-5e52-870e-46c4-4a6c-770c | Puede verificar la integridad de este documento en la siguiente dirección : <https://portafirmas.redsara.es/pf/valida>



<p>Marking/Identification on anchor:</p> <ul style="list-style-type: none"> <li>● Logo</li> <li>● Drill diameter</li> <li>● Length</li> <li>● Anchor type: <ul style="list-style-type: none"> <li>○ Hex head with washer</li> <li>○ Round head</li> <li>○ Pan head</li> <li>○ Countersunk head</li> <li>○ Hex head</li> <li>○ Hex head, hexalobular recess</li> <li>○ Truss head</li> <li>○ Truss head with under head ribs</li> <li>○ Connection thread with hexagon drive</li> <li>○ Internal thread</li> <li>○ Flat washer head with connection thread</li> <li>○ Hex washer head with connection thread</li> <li>○ Hex head with connection thread</li> <li>○ AMROF flex with coupler nut</li> <li>○ AMROH flex with coupler nut</li> <li>○ AMRHH flex with coupler nut</li> <li>○ AMROC flex without washer</li> </ul> </li> </ul>		<ul style="list-style-type: none"> <li>AMDEX</li> <li>AMRND</li> <li>AMPAN</li> <li>AMDAV</li> <li>AMHEX</li> <li>AMTEX</li> <li>AMTRU</li> <li>AMURI</li> <li>AMDTH</li> <li>AMROD</li> <li>AMROF</li> <li>AMROH</li> <li>AMRHH</li> <li>AMROO</li> <li>AMRCC</li> <li>AMRHC</li> <li>AMROC</li> </ul>
AnchorMark AMDEX concrete screw		<b>Annex A4</b>
<p><b>Product description</b></p> <p>Identification and materials</p>		





### Carbon Steel

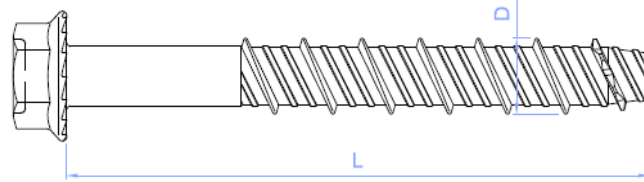

Head marking:  
Identifying mark: AMDEX  
Drill bit size: e.g. 10mm  
Length L: e.g. 100 mm  
Material: Carbon Steel

### Bimetal

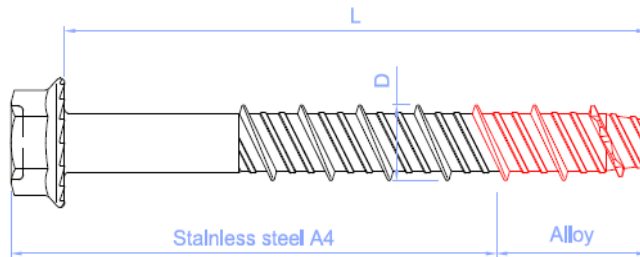
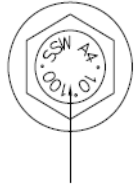

Head marking:  
Identifying mark: SSW  
Drill bit size: e.g. 10 mm  
Length L: e.g. 100 mm  
Material: A4 Stainless Steel

**Table A1: Materials**

Item	Designation	AnchorMark AMDEX concrete screw (Carbon Steel)	AnchorMark AMDEX concrete screw (Bimetal)
1	Anchor Body	Carbon steel wire rod cold forged. Allowed coatings: <ul style="list-style-type: none"> <li>Zinc plated <math>\geq 5 \mu\text{m}</math> ISO 4042 Zn5</li> <li>Silver ruspert 1000/2000hours ISO9227</li> <li>Zinc flake <math>\geq 5 \mu\text{m}</math> EN 10683</li> <li>Mechanical plated <math>\geq 30 \mu\text{m}</math> EN ISO 12683 Zn 40 M(Fe)</li> </ul>	Shaft and head: stainless steel grade A4 ISO 3506-1  Tip: hardened carbon steel

AnchorMark AMDEX concrete screw

**Product description**

Identification and materials

**Annex A5**



**Installed condition**

- $h_{ef}$ : Effective anchorage depth
- $h_1$ : Depth of drilled hole
- $h_{nom}$ : Overall anchor embedment depth in the concrete
- $h_{min}$ : Minimum thickness of concrete member
- $t_{fix}$ : Thickness of fixture
- $d_0$ : Nominal diameter of drill bit
- $d_f$ : Diameter of clearance hole in fixture
- $t_{fix}$ : Fixture thickness

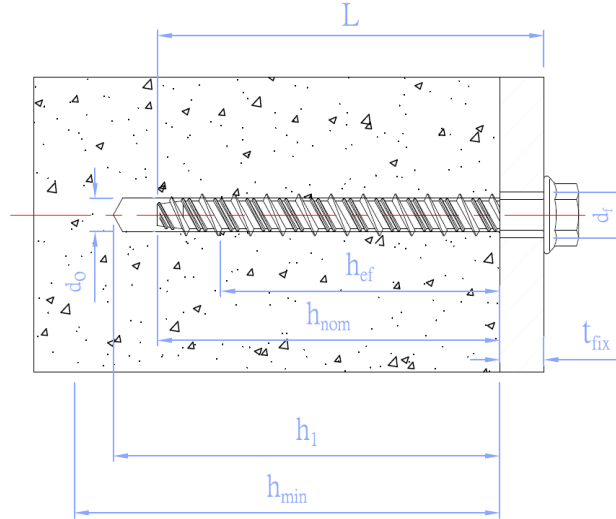

**Drawing A1.** Installed condition for anchors AMDEX,AMRND, AMPAN,AMDAV, AMHEX,AMTEX,AMTRU, and AMURI

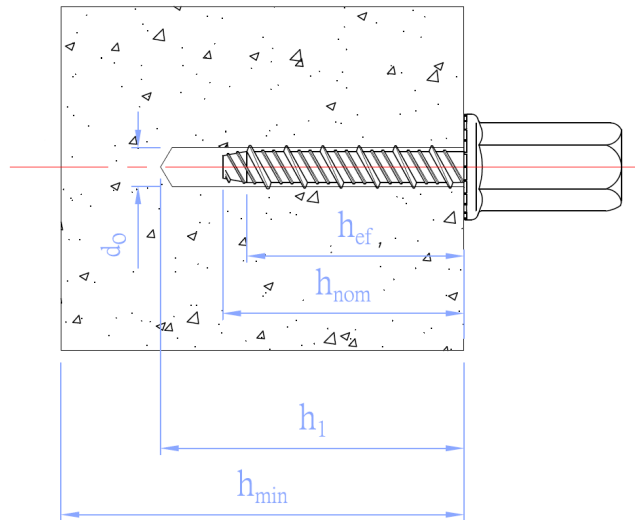

**Drawing A2.** Installed condition for anchors AMDTH, AMROD, AMROF, AMROH, AMRHH, AMROO, AMRCC, AMRHC and AMROC

<b>AnchorMark AMDEX concrete screw</b>	<b>Annex A6</b>
<b>Product description</b>	
Installed condition	



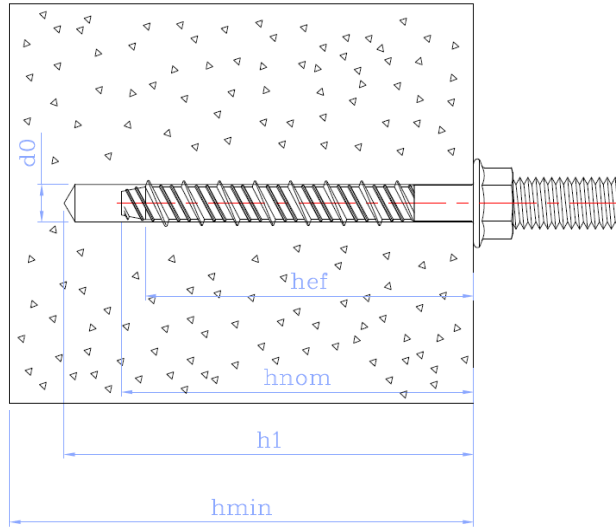

**Drawing A3.** Installed condition for anchors AMDTH, AMROD, AMROF, AMROH, AMRHH, AMROO, AMRCC, AMRHC and AMROC

AnchorMark AMDEX concrete screw	Annex A7
<b>Product description</b>	
Installed condition	



### **Specification of intended use**

#### **Anchorage subjected to:**

- Static or quasi static loads: all sizes and embedment depths.
- Fire exposure up to 120 minutes
- Performances C1 and C2 (seismic) for carbon Steel screws as shown below:

Size	6		8		10			12		14	
$h_{nom}$	40	55	50	60	60	70	85	75	105	75	110
C1	✓	✓		✓			✓		✓		✓
C2				✓			✓		✓		✓

#### **Base materials:**

- Reinforced and unreinforced normal weight concrete without fibers according to EN 206:2013 + A1:2016.
- Strength classes C20/25 to C50/60 according to EN 206:2013 + A1:2016.
- Cracked and uncracked concrete.

#### **Use conditions (environmental conditions):**

- The anchor Carbon Steel shall be used in dry internal conditions.
- The anchor Bimetal shall be used in dry internal conditions, external atmospheric exposure (including industrial and marine environment) or permanent internal damp conditions if there are no particular aggressive conditions. Such particular aggressive conditions are e.g., permanent, alternating immersion in seawater or the splash zone of seawater, chloride atmosphere of indoor swimming pools or atmosphere with extreme chemical pollution (e.g., in desulphurization plants or road tunnels where de-icing materials are used). Atmospheres under Corrosion Resistance Class CRC III according to EN 1993-1-4:2006+A1:2015 annex A.
- The anchor may be used for anchorages with requirements related to resistance to fire.

#### **Design:**

- Anchorages are designed under the responsibility of an engineer experienced in anchorages and concrete.
- Verifiable calculation rules and drawings are prepared taking into account of the loads to be attached. The position of the anchor is indicated on the design drawings (e.g. position of the anchor relative to reinforcement or to supports, etc.)
- Anchorages under static or quasi-static loads are designed for design Method A in accordance with EN 1992-4:2018
- Anchorages under seismic actions are designed in accordance with EN 1992-4:2018. Anchorages shall be positioned outside of critical regions (e.g. plastic hinges) of the concrete structure. Fastening in stand-off installation or with grout layer are not allowed.
- Anchorages under fire exposure are designed in accordance with EN 1992-4:2018. It must be ensured that local spalling of the concrete cover does not occur.
- Shear assessment only covers the shear force induced by the fixed piece, i.e. the piece located between the anchor head and the concrete block (piece contained in  $t_{fix}$ , see Drawing A1).

AnchorMark AMDEX concrete screw

**Intended use**

Specifications

**Annex B1**



**Installation:**

- Hammer drilling only.
- Anchor installation carried out by appropriately qualified personal and under the supervision of the person responsible for technical matters of the site.
- In case of aborted hole: new drilling at a minimum distance away of twice the depth of aborted hole or smaller distance if the aborted hole is filled with high strength mortar and if under shear or oblique tension load it is not the direction of the load application.
- After installation further turning of the anchor is not possible.
- The head of the anchor is supported on the fixture, as it is shown in Drawing A1, and it must not be damaged.

**Installation process**

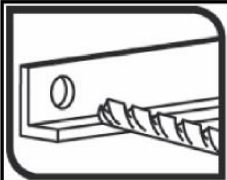
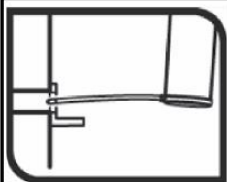
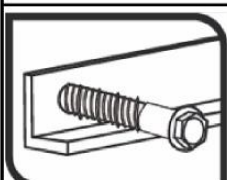
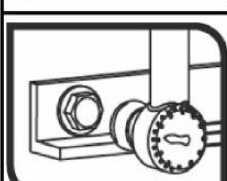
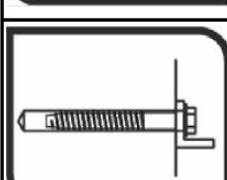
	<p><b>1. DRILL</b></p> <p>Drill a hole into the base material of correct diameter and depth by using a carbide drill bit in rotary plus hammer mode.</p>
	<p><b>2. BLOW and CLEAN</b></p> <p>Remove dust and debris from hole and loose particles left from drilling by using hand pump, compressed air or vacuum.</p>
	<p><b>3. INSTALL</b></p> <p>Hold screw anchor perpendicular direction into the base material through fixtures.</p>
	<p><b>4. APPLY TORQUE</b></p> <p>Select a power impact wrench or a torque wrench (e.g: Bosch GDS 18E, power input: 500 W; torque: 50-250 Nm). Power impact wrench does not exceed over torque Tinst.</p>
	<p><b>5. CHECK</b></p> <p>The head must be undamaged and in contact with the fixture. When screw head attach fixture or concrete surface firmly, further turning of the head is unnecessary.</p>

AnchorMark AMDEX concrete screw

**Intended use**

Specifications and installation procedure

**Annex B2**



**Table B1: Installation parameters for Carbon Steel**

Installation parameters Carbon Steel		Performance									
		6			8		10				
$h_{nom}$	Overall anchor embedment depth in the concrete:	[mm]	40	55		50	60	60	70	85	
$d_0$	Nominal diameter of drill bit:	[mm]	6			8		10			
$d_f$	Diameter of clearance hole in fixture:	[mm]	9			12		14			
$d_s$	Outer diameter of the thread:	[mm]	7.5			10.5		12.5			
$d_k$	Core diameter:	[mm]	5.4			7.2		9.0			
$h_{min}$	Minimum thickness of concrete member:	[mm]	100	80	100	100	100	100	105	130	
$h_1$	Depth of drilled hole:	[mm]	50	65		60	70	70	85	100	
$h_{ef}$	Effective anchorage depth:	[mm]	29	42		37	45	44	52	65	
$T_{ins}$	Installation torque:	[Nm]	15			25		50			
$t_{fix}$	Thickness of fixture <sup>1)</sup> :	[mm]	L-40	L-55		L-50	L-60	L-60	L-70	L-85	
$s_{min}$	Minimum allowable spacing:	[mm]	35	50	45	35	50	50	60	70	
$c_{min}$	Minimum allowable edge distance:	[mm]	35	35	45	35	50	40	60	60	

<sup>1)</sup> L = Total length of the fastener

Installation parameters Carbon Steel		Performance				
		12		14		
$h_{nom}$	Overall anchor embedment depth in the concrete:	[mm]	75	105	75	110
$d_0$	Nominal diameter of drill bit:	[mm]	12		14	
$d_f$	Diameter of clearance hole in fixture:	[mm]	16		18	
$d_s$	Outer diameter of the thread:	[mm]	14.2		16.5	
$d_k$	Core diameter:	[mm]	11.3		13.6	
$h_{min}$	Minimum thickness of concrete member:	[mm]	120	170	120	175
$h_1$	Depth of drilled hole:	[mm]	90	120	90	130
$h_{ef}$	Effective anchorage depth:	[mm]	57	82	56	86
$T_{ins}$	Installation torque:	[Nm]	60		80	
$t_{fix}$	Thickness of fixture <sup>1)</sup> :	[mm]	L-75	L-105	L-75	L-110
$s_{min}$	Minimum allowable spacing:	[mm]	70	70	75	100
$c_{min}$	Minimum allowable edge distance:	[mm]	45	45	45	100

<sup>1)</sup> L = Total length of the fastener

AnchorMark AMDEX concrete screw

**Performances**

Installation parameters

**Annex B3**



**Table B2: Installation parameters for Bimetal**

Installation parameters Bimetal			Performance					
			6		8		10	
$h_{nom}$	Overall anchor embedment depth in the concrete:	[mm]	40	55	50	60	70	85
$d_0$	Nominal diameter of drill bit:	[mm]	6		8		10	
$d_f$	Diameter of clearance hole in fixture:	[mm]	9		12		14	
$d_s$	Outer diameter of the thread:	[mm]	7.5		10.5		12.5	
$d_k$	Core diameter:	[mm]	5.2		7.3		9.3	
$h_{min}$	Minimum thickness of concrete member:	[mm]	100	100	100	100	105	130
$h_1$	Depth of drilled hole:	[mm]	50	65	60	70	85	100
$h_{ef}$	Effective anchorage depth:	[mm]	29	42	37	45	52	65
$T_{ins}$	Installation torque:	[Nm]	15	20	25		50	
$t_{fix}$	Thickness of fixture <sup>1)</sup> :	[mm]	L-40	L-55	L-50	L-60	L-70	L-85
$s_{min}$	Minimum allowable spacing:	[mm]	35	35	35	50	60	70
$c_{min}$	Minimum allowable edge distance:	[mm]	35	35	35	50	60	60

<sup>1)</sup> L = Total length of the fastener

AnchorMark AMDEX concrete screw

**Performances**

Installation parameters

**Annex B4**



**Table C1: Characteristic values to tension loads for Carbon Steel**

Characteristic values of resistance to tension loads of design method A			Performance						
			6		8		10		
$h_{nom}$	Overall anchor embedment depth in the concrete:	[mm]	40	55	50	60	60	70	85
<b>Tension loads: steel failure</b>									
$N_{Rk,s}$	Tension steel characteristic resistance:	[kN]	18.7		32.7		51.2		
$\gamma_{Ms}$	Partial safety factor: <sup>1)</sup>	[-]	1.5		1.5		1.5		
<b>Tension loads: pull-out failure in concrete</b>									
$N_{Rk,p,ucr}$	Tension characteristic resistance in C20/25 uncracked concrete:	[kN]	6.0	9.0	12.5 <sup>2)</sup>	12.0 <sup>2)</sup>	22.0 <sup>2)</sup>	20.0 <sup>2)</sup>	34.0 <sup>2)</sup>
$N_{Rk,p,cr}$	Tension characteristic resistance in C20/25 cracked concrete:	[kN]	3.0	6.0	6.0	9.0	14.0 <sup>2)</sup>	12.0	24.0 <sup>2)</sup>
$\psi_c$	C30/37	[-]	1.16	1.22	1.16	1.08	1.14	1.04	1.18
$\psi_c$	C40/45	[-]	1.29	1.41	1.28	1.15	1.25	1.07	1.33
$\psi_c$	C50/60	[-]	1.40	1.55	1.39	1.19	1.34	1.09	1.46
<b>Tension loads: concrete cone and splitting failure</b>									
$\gamma_{ins}$	Installation safety factor: <sup>1)</sup>	[-]	1.2	1.2	1.2	1.2	1.2	1.2	1.0
$h_{ef}$	Effective embedment depth:	[mm]	29	42	37	45	44	52	65
$k_{ucr,N}$	Factor for uncracked concrete:	[-]	11.0						
$N^0_{Rk,c,ucr}$	Tension characteristic resistance in C20/25 uncracked concrete: <sup>3)</sup>	[kN]	7.7	13.4	11.1	14.8	14.4	18.4	25.8
$k_{cr,N}$	Factor for cracked concrete:	[-]	7.7						
$N^0_{Rk,c,cr}$	Tension characteristic resistance in C20/25 cracked concrete: <sup>3)</sup>	[kN]	5.4	9.4	7.8	10.4	10.1	12.9	18.0
$s_{cr,N}$	Critical spacing:	[mm]	3.0 x $h_{ef}$						
$c_{cr,N}$	Critical edge distance:	[mm]	1.5 x $h_{ef}$						
$s_{cr,sp}$	Critical spacing (splitting):	[mm]	3.0 x $h_{ef}$						
$c_{cr,sp}$	Critical edge distance (splitting):	[mm]	1.5 x $h_{ef}$						

<sup>1)</sup> In absence of other national regulations  
<sup>2)</sup> Pull-out failure is not decisive ( $N^0_{Rk,c} < N_{Rk,p}$ )  
<sup>3)</sup> Equation 7.2 from EN 1992-4:2018

AnchorMark AMDEX concrete screw

**Performances**

Characteristic values for tension loads

**Annex C1**





**Table C1: Characteristic values to tension loads for Carbon Steel (continuation)**

Characteristic values of resistance to tension loads of design method A			Performance			
			12		14	
$h_{nom}$	Overall anchor embedment depth in the concrete:	[mm]	75	105	75	110
<b>Tension loads: steel failure</b>						
$N_{Rk,s}$	Tension steel characteristic resistance:	[kN]	80.6		115.9	
$\gamma_{Ms}$	Partial safety factor: <sup>1)</sup>	[-]	1.5		1.5	
<b>Tension loads: pull-out failure in concrete</b>						
$N_{Rk,p,ucr}$	Tension characteristic resistance in C20/25 uncracked concrete:	[kN]	24.0 <sup>2)</sup>	40.0 <sup>2)</sup>	30.0 <sup>2)</sup>	40.0 <sup>2)</sup>
$N_{Rk,p,cr}$	Tension characteristic resistance in C20/25 cracked concrete:	[kN]	19.0 <sup>2)</sup>	32.0 <sup>2)</sup>	20.0 <sup>2)</sup>	30.0 <sup>2)</sup>
$\psi_c$	C30/37	[-]	1.10	1.08	1.13	1.04
$\psi_c$	C40/45	[-]	1.17	1.15	1.24	1.07
$\psi_c$	C50/60	[-]	1.23	1.20	1.33	1.09
<b>Tension loads: concrete cone and splitting failure</b>						
$\gamma_{ins}$	Installation safety factor: <sup>1)</sup>	[-]	1.2	1.0	1.2	1.0
$h_{ef}$	Effective embedment depth:	[mm]	57	82	56	86
$k_{ucr,N}$	Factor for uncracked concrete:	[-]	11.0			
$N^0_{Rk,c,ucr}$	Tension characteristic resistance in C20/25 uncracked concrete: <sup>3)</sup>	[kN]	21.2	36.5	20.6	39.2
$k_{cr,N}$	Factor for cracked concrete:	[-]	7.7			
$N^0_{Rk,c,cr}$	Tension characteristic resistance in C20/25 cracked concrete: <sup>3)</sup>	[kN]	14.8	25.6	14.4	27.5
$s_{cr,N}$	Critical spacing:	[mm]	3.0 x $h_{ef}$			
$c_{cr,N}$	Critical edge distance:	[mm]	1.5 x $h_{ef}$			
$s_{cr,sp}$	Critical spacing (splitting):	[mm]	3.0 x $h_{ef}$			
$c_{cr,sp}$	Critical edge distance (splitting):	[mm]	1.5 x $h_{ef}$			

- <sup>1)</sup> In absence of other national regulations  
<sup>2)</sup> Pull-out failure is not decisive ( $N^0_{Rk,c} < N_{Rk,p}$ )  
<sup>3)</sup> Equation 7.2 from EN 1992-4:2018

AnchorMark AMDEX concrete screw

**Performances**

Characteristic values for tension loads

**Annex C2**



**Table C2: Characteristic values to tension loads for Bimetal**

Characteristic values of resistance to tension loads of design method A		Performance					
		6		8		10	
$h_{nom}$	Overall anchor embedment depth in the concrete: [mm]	40	55	50	60	70	85
<b>Tension loads: steel failure</b>							
$N_{Rk,s}$	Tension steel characteristic resistance: [kN]	17.0		33.5		54.3	
$\gamma_{Ms}$	Partial safety factor: <sup>1)</sup> [-]	1.5		1.5		1.5	
<b>Tension loads: pull-out failure in concrete</b>							
$N_{Rk,p,ucr}$	Tension characteristic resistance in C20/25 uncracked concrete: [kN]	6.0	13.0 <sup>2)</sup>	11.0 <sup>2)</sup>	17.0 <sup>2)</sup>	22.0 <sup>2)</sup>	32.0 <sup>2)</sup>
$N_{Rk,p,cr}$	Tension characteristic resistance in C20/25 cracked concrete: [kN]	2.0	11.0 <sup>2)</sup>	7.5 <sup>2)</sup>	12.0 <sup>2)</sup>	17.0 <sup>2)</sup>	24.0 <sup>2)</sup>
$\psi_c$	C30/37 [-]	1.09	1.11	1.09	1.12	1.09	1.13
$\psi_c$	C40/45 [-]	1.16	1.20	1.16	1.21	1.16	1.23
$\psi_c$	C50/60 [-]	1.22	1.27	1.21	1.28	1.22	1.31
<b>Tension loads: concrete cone and splitting failure</b>							
$\gamma_{ins}$	Installation safety factor: <sup>1)</sup> [-]	1.2	1.2	1.2	1.2	1.2	1.2
$h_{ef}$	Effective embedment depth: [mm]	29	42	37	45	52	65
$k_{ucr,N}$	Factor for uncracked concrete: [-]	11.0					
$N_{Rk,c,ucr}^0$	Tension characteristic resistance in C20/25 uncracked concrete: <sup>3)</sup> [kN]	7.7	13.4	11.1	14.8	18.4	25.8
$k_{cr,N}$	Factor for cracked concrete: [-]	7.7					
$N_{Rk,c,cr}^0$	Tension characteristic resistance in C20/25 cracked concrete: <sup>3)</sup> [kN]	5.4	9.4	7.8	10.4	12.9	18.0
$s_{cr,N}$	Critical spacing: [mm]	3.0 x $h_{ef}$					
$c_{cr,N}$	Critical edge distance: [mm]	1.5 x $h_{ef}$					
$s_{cr,sp}$	Critical spacing (splitting): [mm]	3.0 x $h_{ef}$					
$c_{cr,sp}$	Critical edge distance (splitting): [mm]	1.5 x $h_{ef}$					

- <sup>1)</sup> In absence of other national regulations  
<sup>2)</sup> Pull-out failure is not decisive ( $N_{Rk,c}^0 < N_{Rk,p}$ )  
<sup>3)</sup> Equation 7.2 from EN 1992-4:2018

AnchorMark AMDEX concrete screw

**Performances**

Characteristic values for tension loads

**Annex C3**



**Table C3: Displacements under tension loads for Carbon Steel**

Characteristic values of displacements under tension loads of design method A				Performance						
				6		8		10		
$h_{nom}$	Overall anchor embedment depth in the concrete:	[mm]		40	55	50	60	60	70	85
<b>Displacements under tension loads in uncracked concrete</b>										
N	Service tension load in uncracked concrete C20/25 to C50/60:	[kN]		2.4	3.6	4.4	4.8	5.7	9.5	12.3
$\bar{\delta}_{N0}$	Short term displacement under tension loads:	[mm]		0.06	0.40	0.08	0.40	0.09	0.40	0.12
$\bar{\delta}_{N\infty}$	Long term displacement under tension loads:	[mm]		0.30	1.00	0.35	1.10	0.40	1.40	0.55
<b>Displacements under tension loads in cracked concrete</b>										
N	Service tension load in cracked concrete C20/25 to C50/60:	[kN]		1.2	2.4	2.5	3.6	4.0	5.7	8.6
$\bar{\delta}_{N0}$	Short term displacement under tension loads:	[mm]		0.10	0.60	0.12	0.70	0.15	0.50	0.17
$\bar{\delta}_{N\infty}$	Long term displacement under tension loads:	[mm]		1.10	1.40	1.20	1.20	1.25	1.40	0.55

Characteristic values of displacements under tension loads of design method A				Performance			
				12		14	
$h_{nom}$	Overall anchor embedment depth in the concrete:	[mm]		75	105	75	110
<b>Displacements under tension loads in uncracked concrete</b>							
N	Service tension load in uncracked concrete C20/25 to C50/60:	[kN]		11.3	18.1	8.2	19.0
$\bar{\delta}_{N0}$	Short term displacement under tension loads:	[mm]		0.08	0.10	0.10	0.90
$\bar{\delta}_{N\infty}$	Long term displacement under tension loads:	[mm]		0.40	0.40	0.45	1.40
<b>Displacements under tension loads in cracked concrete</b>							
N	Service tension load in cracked concrete C20/25 to C50/60:	[kN]		7.7	13.3	5.7	11.9
$\bar{\delta}_{N0}$	Short term displacement under tension loads:	[mm]		0.13	0.15	0.20	0.60
$\bar{\delta}_{N\infty}$	Long term displacement under tension loads:	[mm]		1.25	1.35	1.32	1.20

**Table C4: Displacements under tension loads for Bimetal**

Characteristic values of displacements under tension loads of design method A				Performance						
				6		8		10		
$h_{nom}$	Overall anchor embedment depth in the concrete:	[mm]		40	55	50	60	70	85	
<b>Displacements under tension loads in uncracked concrete</b>										
N	Service tension load in uncracked concrete C20/25 to C50/60:	[kN]		2.95	5.47	4.44	7.06	8.76	13.42	
$\bar{\delta}_{N0}$	Short term displacement under tension loads:	[mm]		0.11	0.15	0.23	0.32	0.39	0.54	
$\bar{\delta}_{N\infty}$	Long term displacement under tension loads:	[mm]		0.40	0.50	0.55	0.55	0.60	0.65	
<b>Displacements under tension loads in cracked concrete</b>										
N	Service tension load in cracked concrete C20/25 to C50/60:	[kN]		1.0	4.66	3.09	5.08	7.02	10.25	
$\bar{\delta}_{N0}$	Short term displacement under tension loads:	[mm]		0.18	0.25	0.43	0.54	0.64	0.72	
$\bar{\delta}_{N\infty}$	Long term displacement under tension loads:	[mm]		1.13	1.20	1.33	1.40	1.47	1.47	

AnchorMark AMDEX concrete screw

**Performances**

Displacement under tension loads

**Annex C4**



**Table C5: Characteristic values to shear loads for Carbon Steel**

Characteristic values of resistance to shear loads			Performance						
			6		8		10		
$h_{nom}$	Overall anchor embedment depth in the concrete:	[mm]	40	55	50	60	60	70	85
<b>Shear loads: steel failure without lever arm</b>									
$V_{Rk,s}$	Shear steel characteristic resistance:	[kN]	9.3	7.5	16.3		25.6		
$k_7$	$k_7$ factor: <sup>1)</sup>	[-]	0.8		0.8		0.8		
$\gamma_{Ms}$	Partial safety factor: <sup>2)</sup>	[-]	1.25		1.25		1.25		
<b>Shear loads: steel failure with lever arm</b>									
$M^0_{Rk,s}$	Characteristic bending moment:	[Nm]	15.2		35.3		69.3		
$\gamma_{Ms}$	Partial safety factor: <sup>2)</sup>	[-]	1.25		1.25		1.25		
<b>Shear loads: concrete pryout failure</b>									
$k_8$	$k_8$ factor:	[-]	1.0	1.0	1.2	1.0	1.0	1.0	2.0
$\gamma_{inst}$	Installation safety factor: <sup>2)</sup>	[-]	1.0		1.0		1.0		
<b>Shear loads: concrete edge failure</b>									
$l_f$	Effective anchorage depth under shear loads:	[mm]	29	42	37	45	44	52	65
$d_{nom}$	Nominal outer diameter of screw:	[mm]	6	6	8	8	10	10	10
$\gamma_{inst}$	Installation safety factor: <sup>2)</sup>	[-]	1.0		1.0		1.0		

<sup>1)</sup> The diameter of the clearance hole does not meet the values given in EN 1992-4 Table 6.1. However, the group resistance under shear loading has been verified in the assessment through testing and accounted for in the factor  $k_7$ .

<sup>2)</sup> In absence of other national regulations.

Characteristic values of resistance to shear loads			Performance			
			12		14	
$h_{nom}$	Overall anchor embedment depth in the concrete:	[mm]	75	105	75	110
<b>Shear loads: steel failure without lever arm</b>						
$V_{Rk,s}$	Shear steel characteristic resistance:	[kN]	40.3		57.9	
$k_7$	$k_7$ factor: <sup>1)</sup>	[-]	0.8		0.8	
$\gamma_{Ms}$	Partial safety factor: <sup>2)</sup>	[-]	1.25		1.25	
<b>Shear loads: steel failure with lever arm</b>						
$M^0_{Rk,s}$	Characteristic bending moment:	[Nm]	137.1		235.9	
$\gamma_{Ms}$	Partial safety factor: <sup>2)</sup>	[-]	1.25		1.25	
<b>Shear loads: concrete pryout failure</b>						
$k_8$	$k_8$ factor:	[-]	1.5	2.0	1.6	2.0
$\gamma_{inst}$	Installation safety factor: <sup>2)</sup>	[-]	1.0		1.0	
<b>Shear loads: concrete edge failure</b>						
$l_f$	Effective anchorage depth under shear loads:	[mm]	57	82	56	86
$d_{nom}$	Nominal outer diameter of screw:	[mm]	12	12	14	14
$\gamma_{inst}$	Installation safety factor: <sup>2)</sup>	[-]	1.0		1.0	

<sup>1)</sup> The diameter of the clearance hole does not meet the values given in EN 1992-4 Table 6.1. However, the group resistance under shear loading has been verified in the assessment through testing and accounted for in the factor  $k_7$ .

<sup>2)</sup> In absence of other national regulations.

AnchorMark AMDEX concrete screw

**Performances**

Characteristic values for shear loads

**Annex C5**



**Table C6: Characteristic values to shear loads for Bimetal**

Characteristic values of resistance to shear loads		Performance					
		6		8		10	
$h_{nom}$	Overall anchor embedment depth in the concrete: [mm]	40	55	50	60	70	85
<b>Shear loads: steel failure without lever arm</b>							
$V_{Rk,s}$	Shear steel characteristic resistance: [kN]	8.5		16.7		27.2	
$k_7$	$k_7$ factor: <sup>1)</sup> [-]	0.8	0.8	1.0		1.0	
$\gamma_{Ms}$	Partial safety factor: <sup>2)</sup> [-]	1.25		1.25		1.25	
<b>Shear loads: steel failure with lever arm</b>							
$M^0_{Rk,s}$	Characteristic bending moment: [Nm]	13.2	13.2	36.6		75.7	
$\gamma_{Ms}$	Partial safety factor: <sup>2)</sup> [-]	1.25		1.25		1.25	
<b>Shear loads: concrete pryout failure</b>							
$k_8$	$k_8$ factor: [-]	1.0	1.0	1.0	1.0	1.09	2.0
$\gamma_{inst}$	Installation safety factor: <sup>2)</sup> [-]	1.0		1.0		1.0	
<b>Shear loads: concrete edge failure</b>							
$l_f$	Effective anchorage depth under shear loads: [mm]	29	42	37	45	52	65
$d_{nom}$	Nominal outer diameter of screw: [mm]	6	6	8	8	10	10
$\gamma_{inst}$	Installation safety factor: <sup>2)</sup> [-]	1.0		1.0		1.0	

<sup>1)</sup> The diameter of the clearance hole does not meet the values given in EN 1992-4 Table 6.1. However, the group resistance under shear loading has been verified in the assessment through testing and accounted for in the factor  $k_7$ .

<sup>2)</sup> In absence of other national regulations.

AnchorMark AMDEX concrete screw

**Performances**

Characteristic values for shear loads

**Annex C6**



**Table C7: Displacements under shear loads for Carbon Steel**

Characteristic values of displacements under shear loads of design method A			Performances						
			6		8		10		
$h_{nom}$	Overall anchor embedment depth in the concrete:	[mm]	40	55	50	60	60	70	85
<b>Displacements under shear loads in uncracked concrete</b>									
$V$	Service shear load in uncracked concrete C20/25 to C50/60:	[kN]	3.0	3.6	4.4	4.8	5.7	9.5	12.3
$\delta_{V0}$	Short term displacement under shear loads:	[mm]	0.47	0.4	0.50	0.40	0.40	0.40	0.80
$\delta_{V\infty}$	Long term displacement under shear loads:	[mm]	0.70	1.0	0.75	1.10	0.60	1.40	1.20
<b>Displacements under shear loads in cracked concrete</b>									
$V$	Service shear load in cracked concrete C20/25 to C50/60:	[kN]	2.1	2.4	3.1	3.6	4.0	5.7	8.6
$\delta_{V0}$	Short term displacement under shear loads:	[mm]	0.40	0.60	0.45	0.70	0.50	0.50	0.6
$\delta_{V\infty}$	Long term displacement under shear loads:	[mm]	0.60	1.40	0.67	1.20	0.75	1.40	0.90

Characteristic values of displacements under shear loads of design method A			Performances			
			12		14	
$h_{nom}$	Overall anchor embedment depth in the concrete:	[mm]	75	105	75	110
<b>Displacements under shear loads in uncracked concrete</b>						
$V$	Service shear load in uncracked concrete C20/25 to C50/60:	[kN]	8.4	17.4	8.2	19.0
$\delta_{V0}$	Short term displacement under shear loads:	[mm]	1.00	1.10	0.55	0.90
$\delta_{V\infty}$	Long term displacement under shear loads:	[mm]	1.50	1.80	0.82	1.4
<b>Displacements under shear loads in cracked concrete</b>						
$V$	Service shear load in cracked concrete C20/25 to C50/60:	[kN]	5.9	12.2	5.7	11.9
$\delta_{V0}$	Short term displacement under shear loads:	[mm]	0.85	1.00	0.50	0.60
$\delta_{V\infty}$	Long term displacement under shear loads:	[mm]	1.20	1.50	0.75	1.20

<sup>1)</sup> No Performance Determined (NPD)

**Table C8: Displacements under shear loads for Bimetal**

Characteristic values of displacements under shear loads of design method A			Performances					
			6		8		10	
$h_{nom}$	Overall anchor embedment depth in the concrete:	[mm]	40	55	50	60	70	85
<b>Displacements under shear loads in uncracked concrete</b>								
$V$	Service shear load in uncracked concrete C20/25 to C50/60:	[kN]	2.7	3.3	4.0	5.3	8.0	11.2
$\delta_{V0}$	Short term displacement under shear loads:	[mm]	1.42	1.55	1.64	1.75	1.78	2.11
$\delta_{V\infty}$	Long term displacement under shear loads:	[mm]	2.13	2.33	2.46	2.63	2.67	3.17
<b>Displacements under shear loads in cracked concrete</b>								
$V$	Service shear load in cracked concrete C20/25 to C50/60:	[kN]	1.9	2.3	2.8	3.7	5.6	7.8
$\delta_{V0}$	Short term displacement under shear loads:	[mm]	1.22	1.34	1.45	1.52	1.57	1.67
$\delta_{V\infty}$	Long term displacement under shear loads:	[mm]	1.83	2.01	2.18	2.28	2.36	2.51

AnchorMark AMDEX concrete screw

**Performances**

Displacements under shear loads

**Annex C7**



**Table C9: Essential characteristics for seismic performance category C1 for Carbon Steel**

Essential characteristics for seismic performance category C1			Performances					
			6	8	10	12	14	
$h_{nom}$	Overall anchor embedment depth in the concrete:	[mm]	40	55	60	85	105	110
<b>Steel failure for tension and shear loads</b>								
$N_{Rk,s,C1}$	Characteristic resistance:	[kN]	18.7	32.7	51.2	80.6	115.9	
$\gamma_{Ms}$	Partial safety factor <sup>1)</sup> :	[-]	1.5	1.5	1.5	1.5	1.5	1.5
$V_{Rk,s,C1}$	Characteristic resistance:	[kN]	6.4	7.5	16.3	24.3	39.9	57.9
$\gamma_{Ms}$	Partial safety factor <sup>1)</sup> :	[-]	1.25	1.25	1.25	1.25	1.25	1.25
<b>Pull out failure</b>								
$N_{Rk,p,C1}$	Characteristic resistance in cracked concrete:	[kN]	2.9	5.6	9.0	24.0	24.3	30.0
$\gamma_{inst}$	Robustness:	[-]	1.2	1.2	1.2	1.0	1.0	1.0
<b>Concrete cone failure</b>								
$h_{ef}$	Effective embedment depth:	[mm]	29	42	45	65	82	86
$s_{cr,N}$	Concrete Spacing:	[mm]	87	126	135	195	246	258
$c_{cr,N}$	cone failure Edge distance:	[mm]	43	63	67	98	123	129
$\gamma_{inst}$	Installation safety factor:	[-]	1.2	1.2	1.2	1.0	1.0	1.0
<b>Concrete pry-out failure</b>								
$k_B$	Pry-out factor:	[-]	1.0	1.0	1.0	2.0	2.0	2.0
$\gamma_{inst}$	Installation safety factor:	[-]	1.0	1.0	1.0	1.0	1.0	1.0
<b>Concrete edge failure</b>								
$l_t = h_{ef}$	Effective length of fastener under shear loads:	[mm]	29	42	45	65	82	86
$d_{nom}$	Nominal outer diameter of screw:	[mm]	6	6	8	10	12	14
$\gamma_{inst}$	Installation safety factor:	[-]	1.0	1.0	1.0	1.0	1.0	1.0

<sup>1)</sup> In absence of other national regulations

AnchorMark AMDEX concrete screw

**Performances**

Essential characteristics for seismic performance category C1

**Annex C8**



**Table C10: Essential characteristics for seismic performance category C2 for Carbon Steel**

Essential characteristics for seismic performance category C2			Performances			
			8	10	12	14
$h_{nom}$	Overall anchor embedment depth in the concrete:	[mm]	60	85	105	110
<b>Steel failure for tension and shear loads</b>						
$N_{Rk,s,C2}$	Characteristic resistance:	[kN]	32.7	51.2	80.6	115.9
$\gamma_{Ms}$	Partial safety factor <sup>1)</sup> :	[-]	1.5	1.5	1.5	1.5
$V_{Rk,s,C2}$	Characteristic resistance:	[kN]	13.7	16.1	28.3	41.1
$\gamma_{Ms}$	Partial safety factor <sup>1)</sup> :	[-]	1.25	1.25	1.25	1.25
<b>Pull out failure</b>						
$N_{Rk,p,C2}$	Characteristic resistance in cracked concrete:	[kN]	5.2	11.0	3.2	9.6
$\gamma_{inst}$	Robustness:	[-]	1.2	1.0	1.0	1.0
<b>Concrete cone failure</b>						
$h_{ef}$	Effective embedment depth:	[mm]	45	65	82	86
$s_{cr,N}$	Concrete Spacing:	[mm]	135	195	246	258
$c_{cr,N}$	cone failure Edge distance:	[mm]	68	98	123	129
$\gamma_{inst}$	Installation safety factor:	[-]	1.2	1.0	1.0	1.0
<b>Concrete pry-out failure</b>						
$k_8$	Pry-out factor:	[-]	1.0	2.0	2.0	2.0
$\gamma_{inst}$	Installation safety factor:	[-]	1.0	1.0	1.0	1.0
<b>Concrete edge failure</b>						
$l_f = h_{ef}$	Effective length of fastener under shear loads:	[mm]	45	65	82	86
$d_{nom}$	Nominal outer diameter of screw:	[mm]	8.0	10.0	12.0	14.0
$\gamma_{inst}$	Installation safety factor:	[-]	1.0	1.0	1.0	1.0
<b>Displacements</b>						
$\bar{\Delta}_{N,C2} (DLS)$	Displacement at	[mm]	0.15	0.35	0.65	0.73
$\bar{\Delta}_{V,C2} (DLS)$	Damage Limitation State: <sup>2)</sup>	[mm]	4.15	5.16	5.65	5.67
$\bar{\Delta}_{N,C2} (ULS)$	Displacement at	[mm]	1.41	1.11	4.66	2.06
$\bar{\Delta}_{V,C2} (ULS)$	Ultimate Limitation State: <sup>2)</sup>	[mm]	8.27	7.90	12.14	7.90

DLS: Damage Limitation State: see EN 1992-4, 2.2.1)

ULS: Ultimate Limitation State: see EN 1992-4 2.2.1)

<sup>1)</sup> In absence of other national regulations.

<sup>2)</sup> The listed displacements represent mean values.

AnchorMark AMDEX concrete screw

**Performances**

Essential characteristics for seismic performance category C2

**Annex C9**





**Table D1: Characteristic values to fire resistance for Carbon Steel**

Fire resistance duration = 30 minutes			Performances										
			6		8		10		12		14		
$h_{nom}$	Overall anchor embedment depth in the concrete:	[mm]	40	55	50	60	60	70	85	75	105	75	110
<b>Tension loads, steel failure</b>													
$N_{Rk,s,fi,30}$	Characteristic resistance:	[kN]	0.23	0.23	0.41	0.41	0.95	0.95	0.95	2.02	2.02	2.91	2.91
<b>Pull-out failure</b>													
$N_{Rk,p,fi,30}$	Character. resistance in concrete:	[kN]	0.77	1.43	1.58	2.28	3.66	3.60	6.09	4.85	8.38	5.04	7.43
<b>Concrete cone failure <sup>1)</sup></b>													
$N_{Rk,c,fi,30}$	Character. resistance in concrete:	[kN]	0.78	1.97	1.43	2.34	2.21	3.36	5.86	4.22	10.48	4.04	11.81
<b>Shear loads steel failure without lever arm</b>													
$V_{Rk,s,fi,30}$	Characteristic resistance:	[kN]	0.23	0.23	0.41	0.41	0.95	0.95	0.95	2.02	2.02	2.91	2.91
<b>Shear loads, steel failure with lever arm</b>													
$M_{Rk,s,fi,30}$	Characteristic bending resistance:	[Nm]	0.19	0.19	0.44	0.44	1.29	1.29	1.29	3.43	3.43	5.93	5.93

Fire resistance duration = 60 minutes			Performances										
			6		8		10		12		14		
$h_{nom}$	Overall anchor embedment depth in the concrete:	[mm]	40	55	50	60	60	70	85	75	105	75	110
<b>Tension loads, steel failure</b>													
$N_{Rk,s,fi,60}$	Characteristic resistance:	[kN]	0.21	0.21	0.37	0.37	0.83	0.83	0.83	1.51	1.51	2.18	2.18
<b>Pull-out failure</b>													
$N_{Rk,p,fi,60}$	Character. resistance in concrete:	[kN]	0.77	1.43	1.58	2.28	3.66	3.60	6.09	4.85	8.38	5.04	7.43
<b>Concrete cone failure <sup>1)</sup></b>													
$N_{Rk,c,fi,60}$	Character. resistance in concrete:	[kN]	0.78	1.97	1.43	2.34	2.21	3.36	5.86	4.22	10.48	4.04	11.81
<b>Shear loads steel failure without lever arm</b>													
$V_{Rk,s,fi,60}$	Characteristic resistance:	[kN]	0.21	0.21	0.37	0.37	0.83	0.83	0.83	1.51	1.51	2.18	2.18
<b>Shear loads, steel failure with lever arm</b>													
$M_{Rk,s,fi,60}$	Characteristic bending resistance:	[Nm]	0.17	0.17	0.40	0.40	1.12	1.12	1.12	2.57	2.57	4.45	4.45

<sup>1)</sup> As a rule, splitting failure can be neglected when cracked concrete and reinforcement is assumed.

Note: In absence of other national regulations, the partial safety factor for resistance under fire exposure  $\gamma_{M,fi} = 1.0$  is recommended for steel failure and concrete related failure modes under shear loading. In case of concrete related failure modes under tension  $\gamma_{M,fi} = \gamma_{inst.}$ .

AnchorMark AMDEX concrete screw

**Performances**  
Characteristic values for fire resistance

**Annex D1**



**Table D1: Characteristic values to fire resistance for Carbon Steel (continuation)**

Fire resistance duration = 90 minutes			Performances										
			6		8		10			12		14	
$h_{nom}$	Overall anchor embedment depth in the concrete:	[mm]	40	55	50	60	60	70	85	75	105	75	110
<b>Tension loads, steel failure</b>													
$N_{Rk,s,fi,90}$	Characteristic resistance:	[kN]	0.16	0.16	0.29	0.29	0.64	0.64	0.64	1.31	1.31	1.89	1.89
<b>Pull-out failure</b>													
$N_{Rk,p,fi,90}$	Character. resistance in concrete:	[kN]	0.77	1.43	1.58	2.28	3.66	3.60	6.09	4.85	8.38	5.04	7.43
<b>Concrete cone failure <sup>1)</sup></b>													
$N_{Rk,c,fi,90}$	Character. resistance in concrete:	[kN]	0.78	1.97	1.43	2.34	2.21	3.36	5.86	4.22	10.48	4.04	11.81
<b>Shear loads steel failure without lever arm</b>													
$V_{Rk,s,fi,90}$	Characteristic resistance:	[kN]	0.16	0.16	0.29	0.29	0.64	0.64	0.64	1.31	1.31	1.89	1.89
<b>Shear loads, steel failure with lever arm</b>													
$M_{Rk,s,fi,90}$	Characteristic bending resistance:	[Nm]	0.13	0.13	0.31	0.31	0.86	0.86	0.86	2.23	2.23	3.85	3.85

Fire resistance duration = 120 minutes			Performances										
			6		8		10			12		14	
$h_{nom}$	Overall anchor embedment depth in the concrete:	[mm]	40	55	50	60	60	70	85	75	105	75	110
<b>Tension loads, steel failure</b>													
$N_{Rk,s,fi,120}$	Characteristic resistance:	[kN]	0.11	0.11	0.20	0.20	0.51	0.51	0.51	1.01	1.01	1.45	1.45
<b>Pull-out failure</b>													
$N_{Rk,p,fi,120}$	Character. resistance in concrete:	[kN]	0.62	1.14	1.27	1.82	2.93	2.88	4.87	3.88	6.70	4.03	5.94
<b>Concrete cone failure <sup>1)</sup></b>													
$N_{Rk,c,fi,120}$	Character. resistance in concrete:	[kN]	0.62	1.57	1.15	1.87	1.77	2.69	4.69	3.38	8.39	3.23	9.45
<b>Shear loads steel failure without lever arm</b>													
$V_{Rk,s,fi,120}$	Characteristic resistance:	[kN]	0.11	0.11	0.20	0.20	0.51	0.51	0.51	1.01	1.01	1.45	1.45
<b>Shear loads, steel failure with lever arm</b>													
$M_{Rk,s,fi,120}$	Characteristic bending resistance:	[Nm]	0.09	0.09	0.22	0.22	0.69	0.69	0.69	1.71	1.71	2.96	2.96

<sup>1)</sup> As a rule, splitting failure can be neglected when cracked concrete and reinforcement is assumed.

Note: In absence of other national regulations, the partial safety factor for resistance under fire exposure  $\gamma_{M,fi} = 1.0$  is recommended for steel failure and concrete related failure modes under shear loading. In case of concrete related failure modes under tension  $\gamma_{M,fi} = \gamma_{inst.}$

AnchorMark AMDEX concrete screw

**Performances**  
Characteristic values for fire resistance

**Annex D2**



**Table D2: Spacing and edge distances for Carbon Steel**

Fire resistance duration = 120 minutes			Performances										
			6		8		10		12		14		
$h_{nom}$	Overall anchor embedment depth in the concrete:	[mm]	40	55	50	60	60	70	85	75	105	75	110
$h_{ef}$	Effective anchorage depth:	[mm]	29	42	37	45	44	52	65	57	82	56	86
$S_{cr,N}$	Spacing	[mm]	116	168	148	180	176	208	260	228	328	224	344
$S_{min}$	Minimum spacing	[mm]	35	45	35	50	50	60	70	70	70	75	100
$C_{cr,N}$	Edge distance	[mm]	58	84	74	90	88	104	130	114	164	112	172
$C_{min}$	Minimum edge distance (one side fire)	[mm]	35	45	35	50	40	60	60	45	45	45	100
$C_{min}$	Minimum edge distance (two sides fire)	[mm]	300	300	300	300	300	300	300	300	300	300	300
$\gamma_{Msp}$	Partial safety factor <sup>*)</sup>	[-]	1.0	1.0	1.0	1.0	1.0	1.0	1.0	1.0	1.0	1.0	1.0

\*) In absence of other national regulations

**Concrete pry-out failure**

$k_8$  factor values for concrete screw made of Carbon Steel in Table C5  
According EN 1992-4:2018, these values of  $k_8$  factor and the relevant values of  $N_{Rk,c,fi}$  given in the above tables have to be considered in design.

**Concrete edge failure**

The characteristic resistance  $V^0_{Rk,c,fi}$  in C20/25 to C50/60 concrete is determined by:  
 $V^0_{Rk,c,fi} = 0.25 \times V^0_{Rk,c}$  ( $\leq R90$ ) and  $V^0_{Rk,c,fi} = 0.20 \times V^0_{Rk,c}$  (R120)  
With  $V^0_{Rk,c}$  initial value of the characteristic resistance in cracked concrete C20/25 under normal temperature according to EN 1992-4:2018.

AnchorMark AMDEX concrete screw

**Performances**  
Characteristic values for fire resistance

**Annex D3**



**Table D3: Characteristic values to fire resistance for Bimetal**

Fire resistance duration = 30 minutes				6		8		10	
$h_{nom}$	Overall anchor embedment depth in the concrete:	[mm]		40	55	50	60	70	85
<b>Tension loads, steel failure</b>									
$N_{Rk,s,fi,30}$	Characteristic resistance	[kN]		0.21		0.84		1.70	
<b>Pull-out failure</b>									
$N_{Rk,p,fi,30}$	Character. resistance in concrete C20/25 to C50/60	[kN]		0.53	2.94	1.95	3.20	4.42	6.46
<b>Concrete cone failure<sup>1)</sup></b>									
$N_{Rk,c,fi,30}$	Character. resistance in concrete C20/25 to C50/60	[kN]		0.78	1.97	1.43	2.34	3.36	5.86
<b>Shear loads steel failure without lever arm</b>									
$V_{Rk,s,fi,30}$	Characteristic resistance	[kN]		0.21		0.84		1.70	
<b>Shear loads, steel failure with lever arm</b>									
$M_{Rk,s,fi,30}$	Characteristic bending resistance	[Nm]		0.17		0.92		2.37	

Fire resistance duration = 60 minutes				6		8		10	
$h_{nom}$	Overall anchor embedment depth in the concrete:	[mm]		40	55	50	60	70	85
<b>Tension loads, steel failure</b>									
$N_{Rk,s,fi,60}$	Characteristic resistance	[kN]		0.19		0.67		1.36	
<b>Pull-out failure</b>									
$N_{Rk,p,fi,60}$	Character. resistance in concrete C20/25 to C50/60	[kN]		0.53	2.94	1.95	3.20	4.42	6.46
<b>Concrete cone failure<sup>1)</sup></b>									
$N_{Rk,c,fi,60}$	Character. resistance in concrete C20/25 to C50/60	[kN]		0.78	1.97	1.43	2.34	3.36	5.86
<b>Shear loads steel failure without lever arm</b>									
$V_{Rk,s,fi,60}$	Characteristic resistance	[kN]		0.19		0.67		1.36	
<b>Shear loads, steel failure with lever arm</b>									
$M_{Rk,s,fi,60}$	Characteristic bending resistance	[Nm]		0.15		0.73		1.90	

Fire resistance duration = 90 minutes				6		8		10	
$h_{nom}$	Overall anchor embedment depth in the concrete:	[mm]		40	55	50	60	70	85
<b>Tension loads, steel failure</b>									
$N_{Rk,s,fi,90}$	Characteristic resistance	[kN]		0.15		0.50		1.09	
<b>Pull-out failure</b>									
$N_{Rk,p,fi,90}$	Character. resistance in concrete C20/25 to C50/60	[kN]		0.53	2.94	1.95	3.20	4.42	6.46
<b>Concrete cone failure<sup>1)</sup></b>									
$N_{Rk,c,fi,90}$	Character. resistance in concrete C20/25 to C50/60	[kN]		0.78	1.97	1.43	2.34	3.36	5.86
<b>Shear loads steel failure without lever arm</b>									
$V_{Rk,s,fi,90}$	Characteristic resistance	[kN]		0.15		0.50		1.09	
<b>Shear loads, steel failure with lever arm</b>									
$M_{Rk,s,fi,90}$	Characteristic bending resistance	[Nm]		0.12		0.55		1.52	

<sup>1)</sup> As a rule, splitting failure can be neglected when cracked concrete and reinforcement is assumed.

Note: In absence of other national regulations, the partial safety factor for resistance under fire exposure  $\gamma_{M,fi} = 1.0$  is recommended for steel failure and concrete related failure modes under shear loading. In case of concrete related failure modes under tension  $\gamma_{M,fi} = \gamma_{inst.}$

AnchorMark AMDEX concrete screw

**Performances**  
Characteristic values for fire resistance

**Annex D4**



**Table D3: Characteristic values to fire resistance for Bimetal (continuation)**

Fire resistance duration = 120 minutes			6		8		10	
$h_{nom}$	Overall anchor embedment depth in the concrete:	[mm]	40	55	50	60	70	85
<b>Tension loads, steel failure</b>								
$N_{Rk,s,fi,120}$	Characteristic resistance	[kN]	0.11		0.42		0.95	
<b>Pull-out failure</b>								
$N_{Rk,p,fi,120}$	Character. resistance in concrete C20/25 to C50/60	[kN]	0.42	2.35	1.56	2.56	3.54	5.17
<b>Concrete cone failure<sup>1)</sup></b>								
$N_{Rk,c,fi,120}$	Character. resistance in concrete C20/25 to C50/60	[kN]	0.62	1.57	1.15	1.87	2.69	4.69
<b>Shear loads steel failure without lever arm</b>								
$V_{Rk,s,fi,120}$	Characteristic resistance	[kN]	0.11		0.42		0.95	
<b>Shear loads, steel failure with lever arm</b>								
$M_{Rk,s,fi,120}$	Characteristic bending resistance	[Nm]	0.08		0.46		1.33	

<sup>1)</sup> As a rule, splitting failure can be neglected when cracked concrete and reinforcement is assumed.

Note: In absence of other national regulations, the partial safety factor for resistance under fire exposure  $\gamma_{M,fi} = 1.0$  is recommended for steel failure and concrete related failure modes under shear loading. In case of concrete related failure modes under tension  $\gamma_{M,fi} = \gamma_{inst.}$

**Table D4: Spacing and edge distances for Bimetal**

Spacing and edge distances			6		8		10	
$h_{nom}$	Overall anchor embedment depth in the concrete:	[mm]	40	55	50	60	70	85
$h_{ef}$	Effective anchorage depth:	[mm]	29	42	37	45	52	65
$S_{cr,N}$	Spacing	[mm]	116	168	148	180	208	260
$S_{min}$	Minimum spacing	[mm]	35	35	35	50	60	70
$C_{cr,N}$	Edge distance	[mm]	58	84	74	90	105	130
$C_{min}$	Minimum edge distance (one side fire)	[mm]	35	35	35	50	60	70
$C_{min}$	Minimum edge distance (two sides fire)	[mm]	300	300	300	300	300	300
$\gamma_{Msp}$	Partial safety factor <sup>1)</sup>	[-]	1.0	1.0	1.0	1.0	1.0	1.0

<sup>1)</sup> In absence of other national regulations

**Concrete pry-out failure**

$k_8$  factor values for concrete screw made of Bimetal Steel in Table C6  
According EN 1992-4:2018, these values of  $k_8$  factor and the relevant values of  $N_{Rk,c,fi}$  given in the above tables have to be considered in design.

**Concrete edge failure**

The characteristic resistance  $V_{Rk,c,fi}$  in C20/25 to C50/60 concrete is determined by:  
 $V_{Rk,c,fi} = 0.25 \times V_{Rk,c}$  ( $\leq R90$ ) and  $V_{Rk,c,fi} = 0.20 \times V_{Rk,c}$  (R120)  
With  $V_{Rk,c}$  initial value of the characteristic resistance in cracked concrete C20/25 under normal temperature according to EN 1992-4:2018.

AnchorMark AMDEX concrete screw

**Performances**  
Characteristic values for fire resistance

**Annex D5**

