



Kiwimesh Roof Safe Mesh

Product Technical
Statement &
Installation Guide



ISSUED: JULY 2022 - Version 1

Product Technical Statement

Product

- 1.1 Bayonet Kiwimesh Roof Safe Mesh is a welded mesh made from steel wire comprising of line wires (longitudinal) and cross wires used as a support for roofing insulation and underlay while providing a safety net against falls during initial roof installation and for ongoing maintenance work.
- 1.2 Bayonet Kiwimesh Roof Safe Mesh consists of a welded, mild steel wire mesh with longitudinal wires spaced at 150mm centres and cross wires spaced at 300mm centres.
- 1.3 Bayonet Kiwimesh Roof Safe Mesh is comprised of galvanised wire, 2.00mm in diameter, with a tensile strength exceeding 450mpa. The galvanised coating complies with AS/NZS 4534: 2006 Class W02.

Applications

- 2.1 Provides fall-through protection during roof installation and ongoing maintenance.

Technical Data

- 3.1 Complies with Safety Mesh Standard AS/NZS 4389:2015
- 3.2 Complies with AS/NZS 4534:2006 Class W02

Scope

- 4.1 Bayonet Kiwimesh Roof Safe Mesh is for use as a support for roof underlays and insulation and complies with the following wire and mesh requirements;
 - a. The longitudinal wires have a minimum tensile strength of 550MPa.
 - b. The cross wires have a minimum tensile strength of 450MPa.
- 4.2 Bayonet Kiwimesh Roof Safe Mesh is formed by welding wires and complies with table 1.

Table 1

Minimum nominal diameter of wire mesh	Spacing of longitudinal wires	Spacing of transverse wires	Minimum mass of zinc coating
2.00mm	150±5mm	300±5mm	35g/m ²

Product Technical Statement

Handling & Storage

- 5.1 Do not store the products in the following conditions:
 - a. Under tarpaulins.
 - b. Under polymer sheeting.
 - c. Areas that restrict circulation of air.
 - d. Overnight in warehouses or sheds that show signs of condensation especially through falling temperatures.
 - e. Directly on the ground.
 - f. In storage facilities that have relative humidity exceeding 69%
 - g. On or touching cardboard, paper products, concrete, damp surfaces, cinders, clinkers, unseasoned timber.
 - h. On or near freshly treated timber.
 - i. On or near harmful chemicals even agricultural fertilisers and pesticides or fungicides.
 - j. On or near dissimilar metals structures such as Austenitic stainless steel, Nickel-chromium-iron alloys, Nickel, Gunmetal, Monel, Copper, Phosphor bronze, Ferritic stainless steel, Brass 60/40, Aluminium bronze, Lead, Chromium, Tin.

Technical Literature

Limitations

- 6.1 Not to be used for access or as a working platform.

Durability

- 7.1 Do not use any mesh or fasteners that are showing signs of dark brown rust.
- 7.2 When installed in conditions having a high risk of corrosion adversely affecting the performance within its service life, roof safety mesh shall be protected by the application of a suitable protective coating.
- 7.3 The wire is galvanised in accordance with AS/NZS 4534, Class W02.

Bayonet Kiwimesh

Roof Safe Mesh

Installation Guide

Installation Instructions

General

- 8.1 Bayonet Kiwimesh Roof Safe Mesh shall be positioned in accordance with the following:
- Where Bayonet Kiwimesh Roof Safe Mesh is to be installed under roof sheeting, it must be fitted so that it is underpinned by beams/purlins/rafters or roof support elements made of timber or steel that are part of the roof structure.
 - The Bayonet Kiwimesh Roof Safe Mesh's natural sag shall be pulled taut to ensure the natural sag only occurs between each beam/purlin/rafter or roof support element. No modifications to the mesh is permitted to create an exaggerated sag other than the natural sag. (Please refer to Tautness on page 7 of the Bayonet Kiwimesh Roof Safe Mesh TDS)
 - When using the Bayonet Kiwimesh Roof Safe Mesh with corrugated roof sheeting the (longitudinal wires) wires parallel to the direction of the corrugations of the roof sheeting shall be in contact with the tops of the immediate roof support elements of the sheet. The cross-wires wires shall be on top of the longitudinal wires.
- 8.2 Bayonet Kiwimesh Roof Safe Mesh once installed shall remain in place for fall protection. Bayonet Kiwimesh Roof Safe Mesh shall cover the entire roof area, including penetrations.

Side Lapping Meshes

- 8.3 Joints between adjacent lengths of Bayonet Kiwimesh Roof Safe Mesh, the following shall apply;
- For purlin spacing is 1200mm or less, Bayonet Kiwimesh Roof Safety Mesh must be overlapped by a minimum of one spacing of mesh.
 - Where purlins are spaced between 1200-2200mm, Bayonet Kiwimesh Roof Safety Mesh must be overlapped by a minimum of one mesh spacing (150 mm). Ring Fasteners or equivalent, made from a minimum wire diameter of 1.90mm are required to secure the side lap, installed at maximum 900mm centres between each purlin on one side of the overlap.
 - Where purlins are spaced greater than 2200 mm, Bayonet Kiwimesh Roof Safety Mesh must be overlapped by a minimum of two-mesh spacings (300 mm). Ring Fasteners or equivalent, made from a minimum wire diameter of 1.90mm are required to secure the side lap, installed at maximum 600mm centres between each purlin on both sides of the lap.
- (Please refer to Side Lapping Meshes on page 10 of this technical data sheet.)

Installation Instructions

- 8.4 All longitudinal wires of Bayonet Kiwimesh Roof Safe Mesh shall be fixed to the roof members in one of the following ways, as applicable to the construction of the roof members:

Steel Roof Members

- 8.5 When being installed on roof members of metal construction, the longitudinal wires, including lapped wires, of the Bayonet Kiwimesh Roof Safe Mesh shall be attached in one of the following methods;
- Bayonet Kiwimesh Roof Safe Mesh wires are to be fed through a hole drilled on the upside of the purlin at a spacing of 150 ± 5 mm and then tied off on itself with a minimum four full wraps around the same wire.
 - Bayonet Kiwimesh Roof Safe Mesh wires are to be looped once around the complete roof member with the tail of every wire to be tied off on itself with a minimum four full wraps around the same wire.
 - Bayonet Kiwimesh Roof Safe Mesh wires are required to be attached to a predrilled supporting member with all longitudinal wires (including lapped wires), fed through the predrilled holes in the projecting half of the metal strip with tails of every wire being twisted a minimum four full wraps around the same wire. Installation instructions on how to attach the supporting member to the roof structure can be found in the Bayonet Kiwimesh Roof Safety Mesh installation instruction.

(Please refer to Steel Roof Members on page 11 of this technical data sheet.)

Timber Roof Members

- 8.6 When being installed on roof members of timber construction, the longitudinal wires, of the Bayonet Kiwimesh Roof Safe Mesh shall be attached in one of the following methods;
- The wires shall be bent over and down, and fixed to the sides of the purlins by staples with a coating of galvanised and with not less than 30mm in length and 3.15mm wire diameter.
 - The wires shall be stapled to the tops of the roof members by means of galvanised steel staples of not less than 40mm in length and 3.15mm wire diameter.
- 8.7 Staples are to be located prior to a cross wire and the end of the wire tail, or the end of the wire is bent back and tied off on itself with a minimum four full wraps around the same wire so that individual wires cannot be drawn from a staple.

(Please refer to Timber Roof Members on page 12 of this technical data sheet.)

Installation Instructions

Fixing Longitudinal Wires

8.8 Fixing of the longitudinal wires may be secured to the roof member using galvanised wire loops. The loops are required to be made from a galvanised steel wire with a minimum diameter of 3.15mm. Place the centre of the tying wire loops around the longitudinal wire at a point of intersection of a cross wire, so that a cross wire is between that point and the end of the longitudinal wire, and next passing both ends of the tying wire once completely around the roof members, and then drawing the two tails of the tying wire in opposite directions over the two strands of the tying wire and twisting together with a minimum three complete wraps.

(Please refer to Fixing Longitudinal Wires on page 11 of this technical data sheet.)

Joining Rolls or Sections

8.9 Bayonet Kiwimesh Roof Safety Mesh may be joined at roof members using the following method:

- a. Place the two cross wires together and twist the longitudinal wires around each other.
- b. Twist one longitudinal wire four full wraps around the main portion of the same wire.
- c. Twist the other longitudinal tail wire once around the main portion of the same wire and then four full wraps around the two cross wires.

(Please refer to Joining Rolls or Sections on page 13 of this technical data sheet.)

Installation Instructions

General Layout

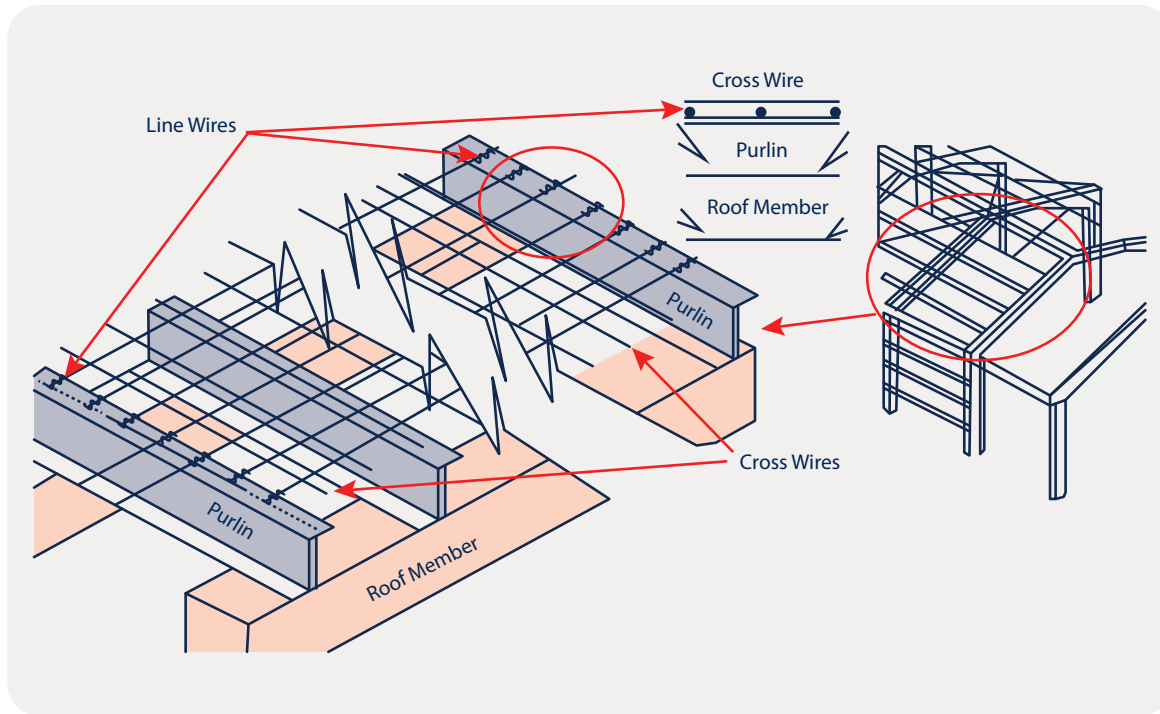

Installation Instructions

General Layout

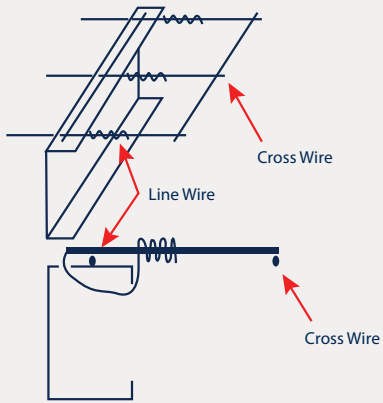

The line wire shall pass through a predrilled hole at a spacing of 150 ± 5 mm on top of the purlin come around the under side of the purlin to wrap the same line wire of the mesh on top of the purlin.

NB! The line wire must be tied off with at least four full turns around the mesh line wire portion.

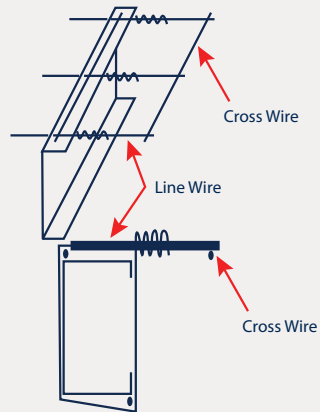

The line wire shall wrap completely around the roof member to twist round itself that is attached to the mesh.

NB! The line wire must be tied off with at least four full turns around the mesh line wire portion.

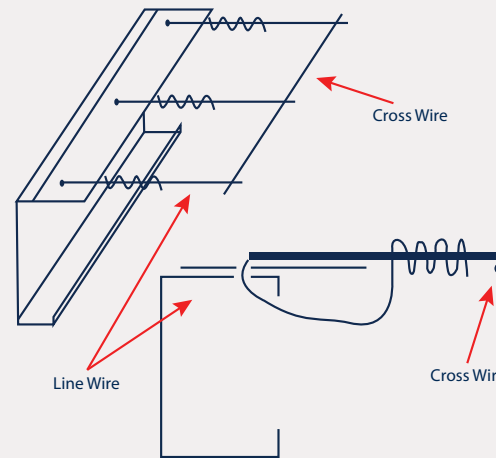

The line wire shall be attached to predrilled hole supporting metal strip member at a spacing of 150 ± 5 mm. The line wire shall pass through the predrilled hole on top of the projecting half of the metal strip to come around the underside of the metal strip to wrap the same line wire of the mesh on top of the metal strip.

NB! The line wire must be tied off with at least four full turns around the mesh line wire portion.

Attachment of the predrilled supporting metal strip member to the roof structure shall be in accordance with manufacturer's installation specification.

Installation Instructions

Side Lapping Meshes

Side-lapped by a minimum of one mesh spacing.

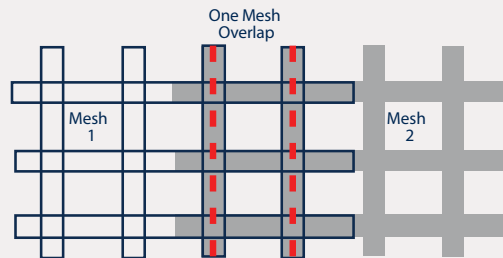
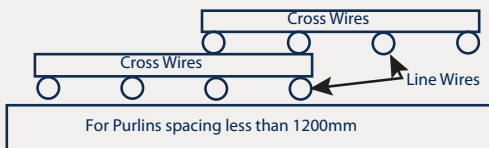

Side-lapped by a min. of one mesh spacing. Side laps shall be secured with ring fasteners fabricated from min. 1.90mm diameter wire, fitted at max. 600mm centres between each purlin on one side of the lap.

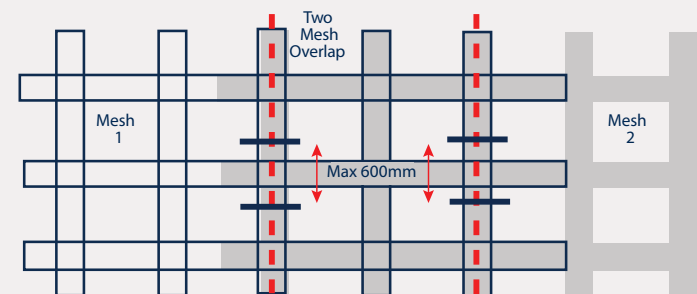
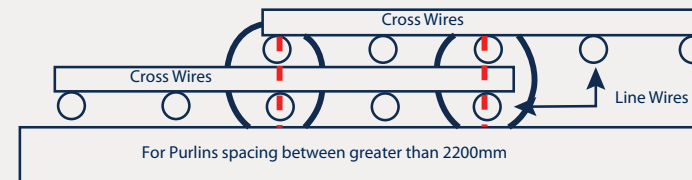

Side-lapped by a min. of one mesh spacing. Side laps shall be secured with ring fasteners fabricated from min. 1.90mm diameter wire, fitted at max. 900mm centres between each purlin on one side of the lap.

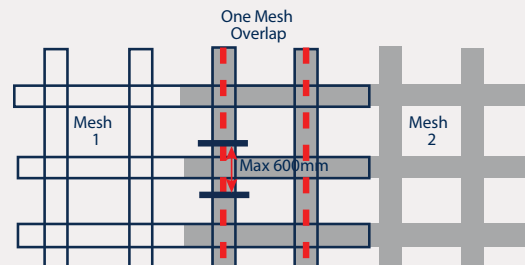
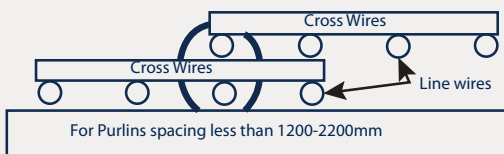

Installation Instructions

Tautness

Mesh shall be pulled taut to ensure only natural sag between each purlin or roof member.

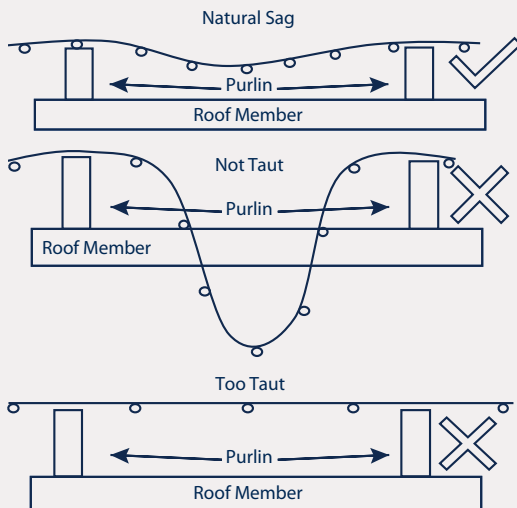

Steel Roof Members

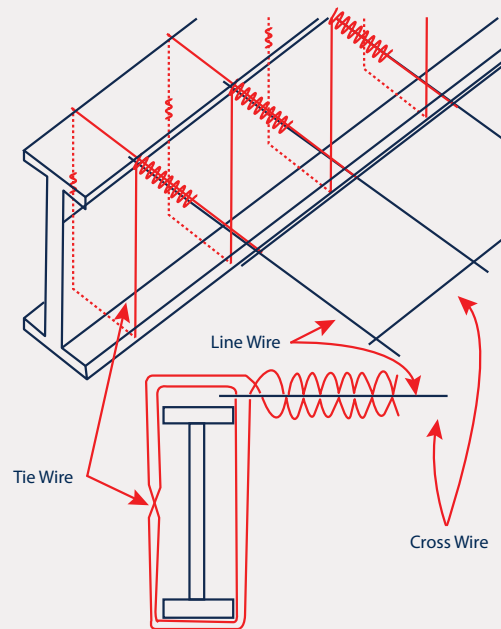

Fixing of line wires to rigid roof members by means of galvanized steel tie wires of not less than 3.15 mm diameter by wrapping the tie wire around the roof member and the wire mesh starting from the roof safety mesh side first. The middle of the tie wire must be placed at the intersection of the line wire and cross wire taking care to start at the outside of the cross wire so as to include the cross wire in the wrap process as below.

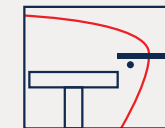

Once wrapped around the member and bring the ends of the tie wire back to the line and cross wire intersection to twist them in opposite directions around the line wire.

NB! The tie wire ends must be tied off with at least four full turns around the mesh line wire portion.

Installation Instructions

Timber Roof Members

The line wire shall be attached to predrilled hole supporting metal strip member at a spacing of 150 ± 5 mm. The line wire shall pass through the predrilled hole on top of the projecting half of the metal strip to come around the underside of the metal strip to wrap the same line wire of the mesh on top of the metal strip.

NB! The line wire must be tied off with at least four full turns around the mesh line wire portion.

Attachment of the predrilled supporting metal strip member to the roof structure shall be in accordance with manufacturer's installation specification.

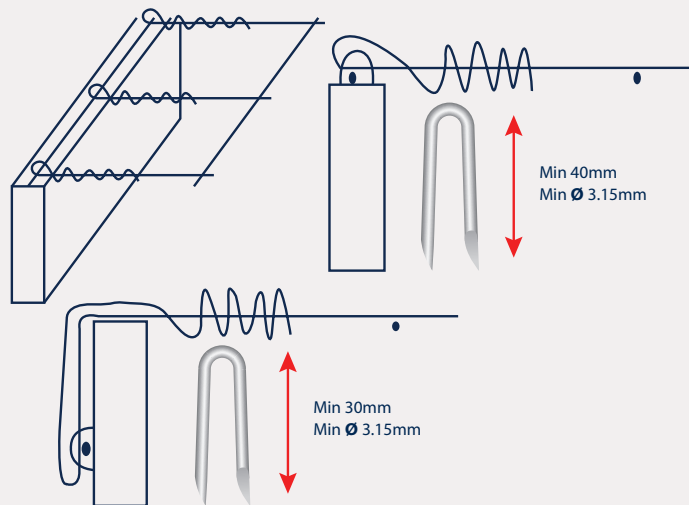

Installation Instructions

Joining rolls or sections

